



TO-92 Plastic-Encapsulate Transistor

3DD13003B TRANSISTOR(NPN)

FEATURES

- power switching applications

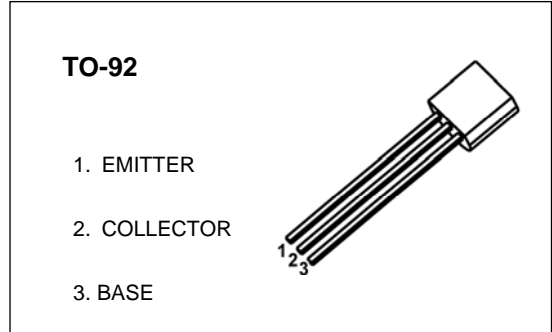

MARKING

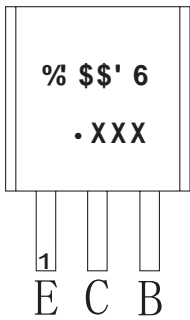

13003B=Device code
 Solid dot=Green molding compound device,
 if none,the normal device
 XXX=Code

Equivalent Circuit

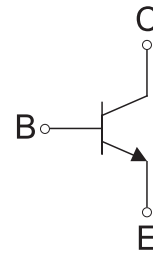

ORDERING INFORMATION

Part Number	Package	Packing Method	Pack Quantity
3DD13003B	TO-92	Bulk	1000pcs/Bag
3DD13003B-TA	TO-92	Tape	2000pcs/Box

MAXIMUM RATINGS (T_a=25°C unless otherwise noted)

Symbol	Parameter	Value	Unit
V _{CBO}	Collector-Base Voltage	700	V
V _{CEO}	Collector-Emitter Voltage	400	V
V _{EBO}	Emitter-Base Voltage	9	V
I _C	Collector Current -Continuous	1.5	A
P _C	Collector Power Dissipation	0.9	W
T _J ,T _{stg}	Operation Junction and Storage Temperature Range	-55 ~150	°C

ELECTRICAL CHARACTERISTICS

$T_a=25^\circ\text{C}$ unless otherwise specified

Parameter	Symbol	Test conditions	Min	Typ	Max	Unit
Collector-base breakdown voltage	$V_{(BR)CBO}$	$I_C=1\text{mA}, I_E=0$	700			V
Collector-emitter breakdown voltage	$V_{(BR)CEO}$	$I_C=10\text{mA}, I_B=0$	400			V
Emitter-base breakdown voltage	$V_{(BR)EBO}$	$I_E=1\text{mA}, I_C=0$	9			V
Collector cut-off current	I_{CBO}	$V_{CB}=700\text{V}, I_E=0$			100	μA
Collector cut-off current	I_{CEO}	$V_{CE}=400\text{V}, I_B=0$			50	μA
Emitter cut-off current	I_{EBO}	$V_{EB}=7\text{V}, I_C=0$			10	μA
DC current gain	h_{FE}	$V_{CE}=10\text{V}, I_C=0.4\text{A}$	20		40	
Collector-emitter saturation voltage	$V_{CE(sat)1}$	$I_C=1.5\text{A}, I_B=0.5\text{A}$			3	V
	$V_{CE(sat)2}$	$I_C=0.5\text{A}, I_B=0.1\text{A}$			0.8	V
Base-emitter saturation voltage	$V_{BE(sat)}$	$I_C=0.5\text{A}, I_B=0.1\text{A}$			1	V
Transition Frequency	f_T	$V_{CE}=10\text{V}, I_C=100\text{mA}, f=1\text{MHz}$	4			MHz
Fall time	t_f	$I_C=1\text{A}$			0.7	μs
Storage time	t_s	$I_{B1}=-I_{B2}=0.2\text{A}$			4	μs

CLASSIFICATION OF h_{FE}

Rank		
Range	20-30	30-40

Typical Characteristics

Static Characteristic

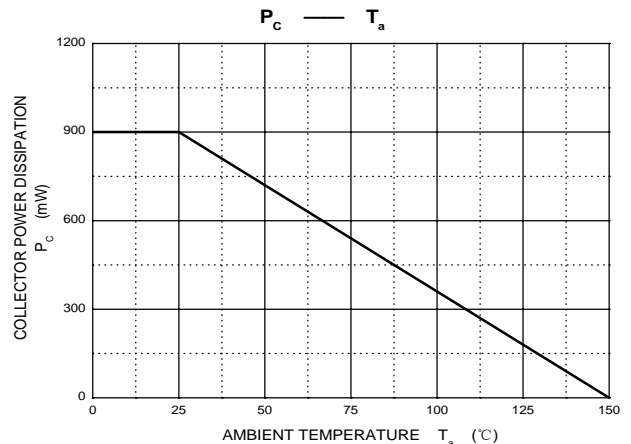
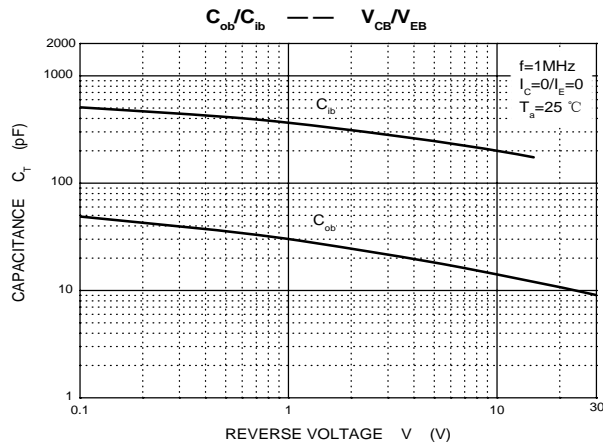
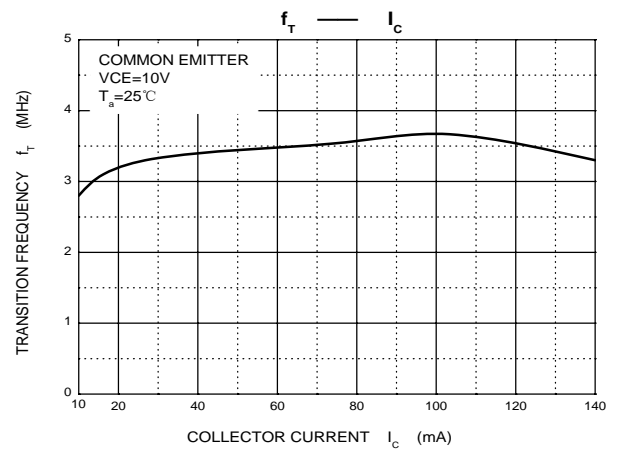
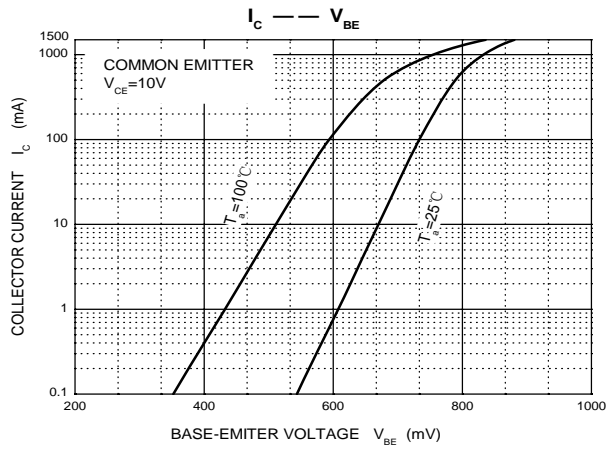
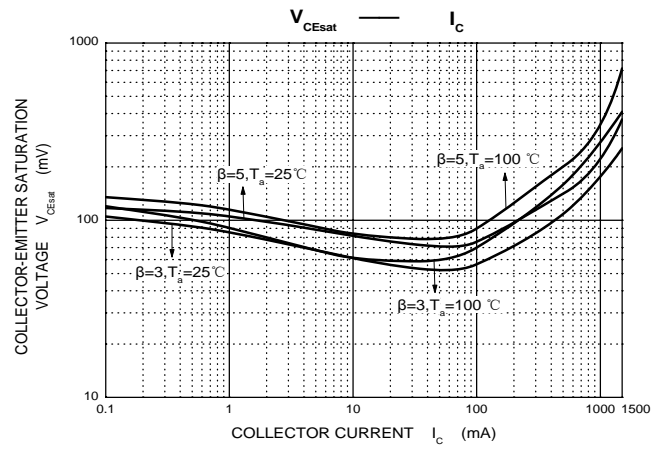
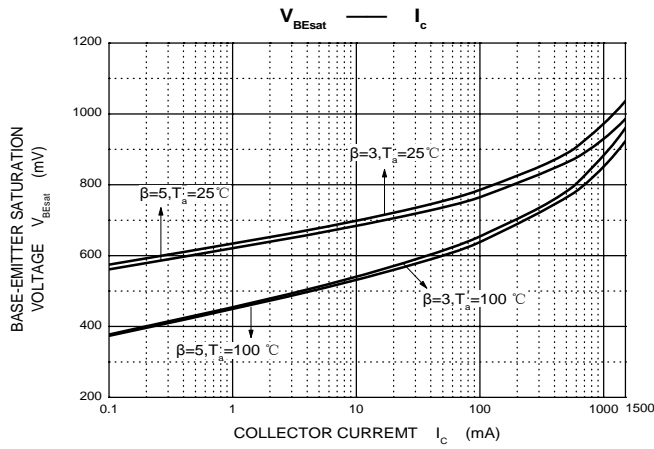
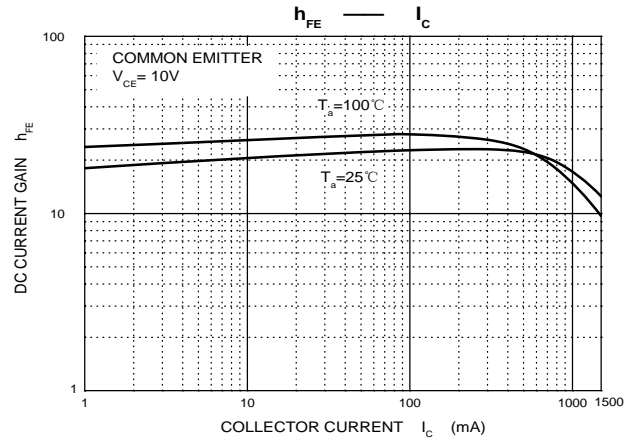
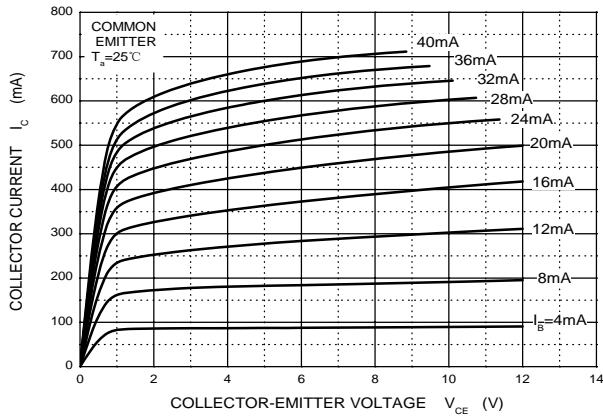

TO-92 Package Outline Dimensions

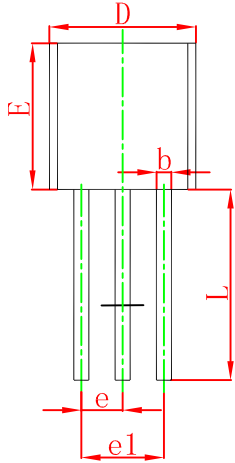
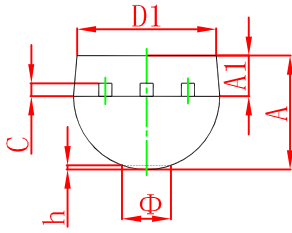

Symbol	Dimensions In Millimeters		Dimensions In Inches	
	Min	Max	Min	Max
A	3.300	3.700	0.130	0.146
A1	1.100	1.400	0.043	0.055
b	0.380	0.550	0.015	0.022
c	0.360	0.510	0.014	0.020
D	4.300	4.700	0.169	0.185
D1	3.430		0.135	
E	4.300	4.700	0.169	0.185
e	1.270 TYP		0.050 TYP	
e1	2.440	2.640	0.096	0.104
L	14.100	14.500	0.555	0.571
Φ		1.600		0.063
h	0.000	0.380	0.000	0.015

TO-92 Suggested Pad Layout

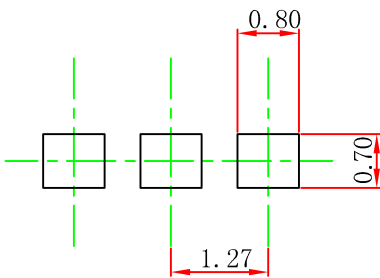

Note:

1. Controlling dimension: in millimeters.
2. General tolerance: $\pm 0.05\text{mm}$.
3. The pad layout is for reference purposes only.

NOTICE

JSCJ reserves the right to make modifications, enhancements, improvements, corrections or other changes without further notice to any product herein. JSCJ does not assume any liability arising out of the application or use of any product described herein.

TO-92 PACKAGE TAPEING DIMENSION

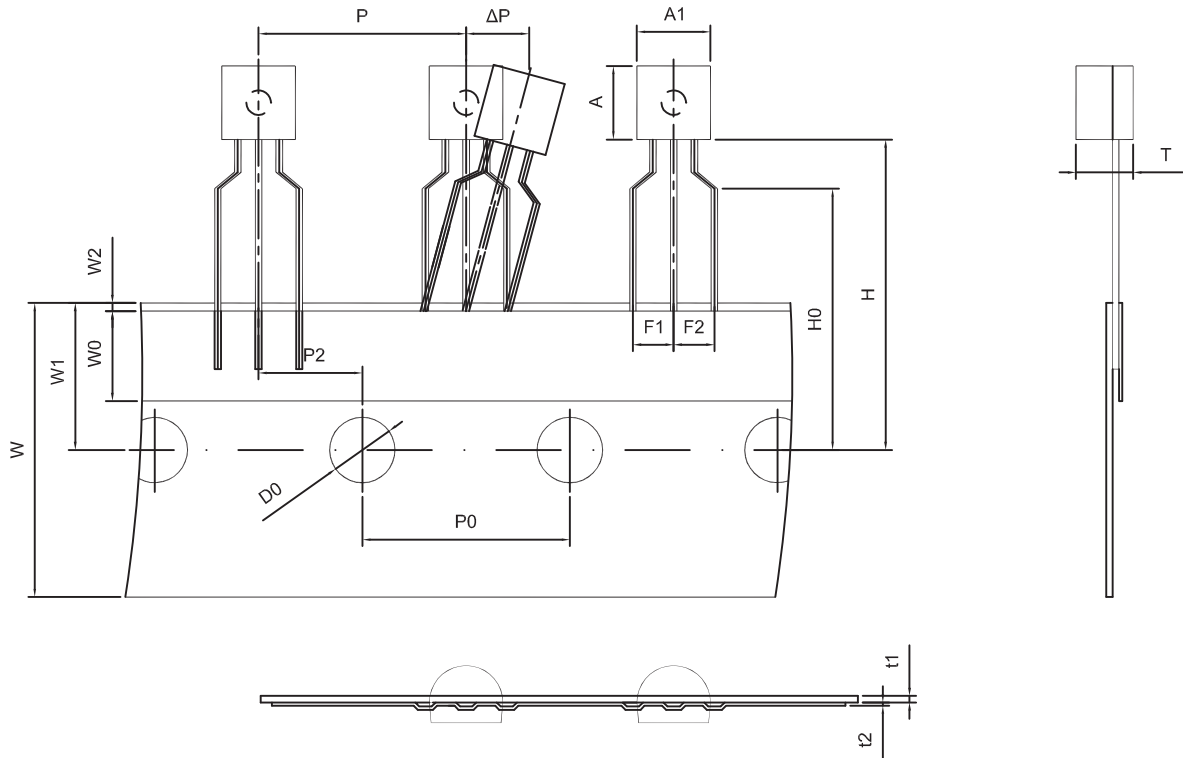

Dimensions are in millimeter								
A1	A	T	P	P0	P2	F1	F2	W
4.5	4.5	3.5	12.7	12.7	6.35	2.5	2.5	18.0
W0	W1	W2	H	H0	D0	t1	t2	ΔP
6.0	9.0	1.0 MAX.	19.0	16.0	4.0	0.4	0.2	0

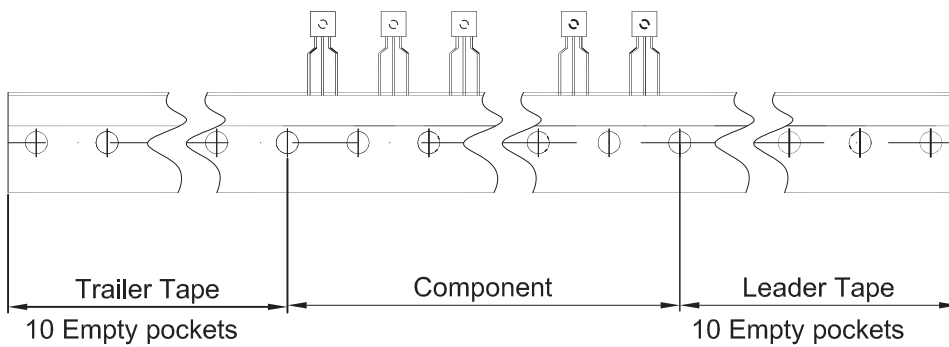

Package	Box	Box Size(mm)	Carton	Carton Size(mm)
TO-92	2000 pcs	333×162×43	20,000 pcs	350×340×250